

THE *General Radio* EXPERIMENTER

VOLUME XIV NO. 12

MAY, 1940

ELECTRICAL MEASUREMENTS AND THEIR INDUSTRIAL APPLICATIONS

Also IN THIS ISSUE

Page
SUBSTITUTION MEASUREMENTS AT RADIO FREQUENCIES 3

A VOLTAGE MULTIPLIER FOR USE WITH THE VACUUM-TUBE VOLTMETER AT RADIO FREQUENCIES

● THE TYPE 726-A VACUUM-TUBE VOLTMETER* has been widely adopted

for measuring voltages from 0.1 v to 150 v in the frequency range from 20 cycles to 100 Mc. With external condenser shunts it has also been used as a radio-frequency ammeter.†

In order to extend still further the usefulness of this instrument by increasing the voltage range, the TYPE 726-PI Voltage Multiplier, shown in Figure 1, has been designed. By means of a capacitance type voltage divider a reduction of 10 : 1 is obtained between the voltage applied to the multiplier and the voltage appearing across the voltmeter terminals. The use of the multiplier therefore extends the upper voltage that can be measured to 1500 volts.

The frequency error of the multiplier is plotted in Figure 2. Over the frequency range from 1 Mc to 100 Mc the error is negligible. At lower frequencies, where the input admittance of the voltmeter probe has an appreciable conductance

FIGURE 1. The voltmeter probe plugs into the 1500-volt multiplier as shown here.



*"TYPE 726-A Vacuum-Tube Voltmeter," *General Radio Experimenter*, Vol. XI, No. 12, p. 1, May, 1937.

†"The TYPE 726-A Vacuum-Tube Voltmeter as a Radio-Frequency Ammeter," *General Radio Experimenter*, Vol. XIII, Nos. 3/4, p. 1, August/September, 1938.



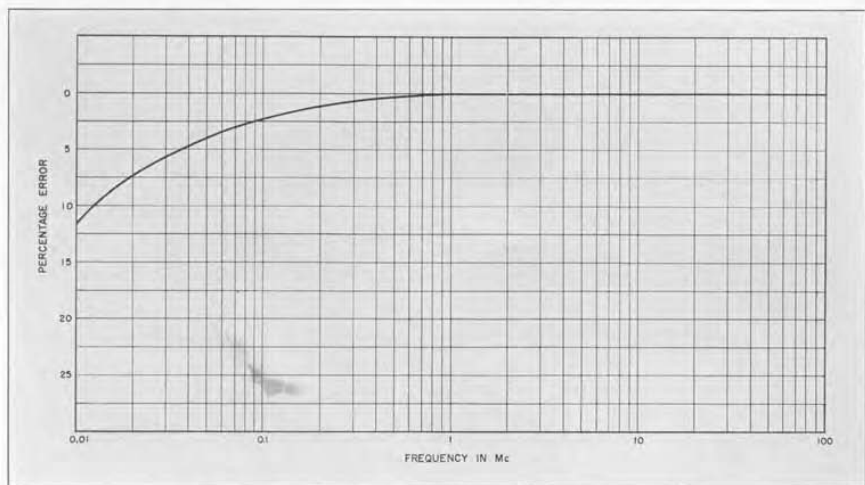

FIGURE 2. Plot of the error in multiplier ratio as a function of frequency.

component compared to the capacitive susceptance, an error appears that increases as the frequency decreases, becoming 5% at a frequency of 40 kc.

The input admittance of the multiplier has been made even lower than that of the voltmeter probe itself, being equivalent, over the frequency range from 100 kc to 100 Mc, to that of a 4.5 μmf condenser of less than 0.5% power factor.

From the design standpoint, an interesting feature is that the flanges used to secure the multiplier to the voltmeter probe, when it is plugged in, are also used to complete the electrostatic shielding of the voltmeter probe. This complete shielding is necessary in order to insure that there is no direct electrostatic pickup to the probe from the voltage to be measured.

— D. B. SINCLAIR

SPECIFICATIONS

Multiplier Ratio: 10 to 1. This gives a total range of 1 volt to 1500 volts when the multiplier is used with the TYPE 726-A Vacuum-Tube Voltmeter.

Frequency Error: The frequency error is shown in Figure 2.

Dimensions: The multiplier adds about 3 inches to the effective length of the probe.

Net Weight: 12 ounces.

Type	Code Word	Price
726-P1	AL0UD	\$15.00



SUBSTITUTION MEASUREMENTS AT RADIO FREQUENCIES AND THEIR APPLICATIONS TO THE TYPE 516-C RADIO-FREQUENCY BRIDGE

● ACCURATE MEASUREMENTS OF UNKNOWN IMPEDANCES

are made almost universally by some type of substitution method because in this manner fewer elements of the measuring circuit need to be calibrated. In general, only those standards of reactance and resistance which are varied in order to effect the substitution will enter into the final equations. The substitution may be complete or partial. In the former case the entire reactance standard is removed from the circuit when the unknown impedance is connected, and this standard must be calibrated for total reactance. In the latter case the standard need be calibrated only for differences, since it remains in circuit at all times. The unknown impedance may be connected either in parallel or in series with the reactance standard, thus giving rise to the two methods, of parallel substitution and of series substitution.

The adjustable reactance standard is almost always an air condenser, both because an air condenser can be accurately calibrated and because it holds its calibration at high frequencies. The only defect of an air condenser when used at low frequencies is that it has dielectric losses. These losses occur in the fixed capacitance of the stator supports and in a properly designed condenser are unaffected by the position of the rotor. For this reason they do not appear in the final results obtained from the parallel substitution method. Other losses, however, which vary with the position of the rotor, such as those caused by dust or moisture on the surface of the condenser plates, will produce

errors in parallel substitution measurements. On the other hand, in the series substitution method the dielectric losses also introduce errors.

In the parallel substitution method the resonant circuit is first tuned, or the bridge is first balanced, with the unknown impedance disconnected. The unknown is then connected in parallel with the standard condenser and the circuit returned to its original condition. The unknown reactance is always measured by the change in capacitance of the standard condenser. Its dissipation factor is found from the change in setting of whatever circuit element is used for resistance balance, either resistance in series or parallel with the standard condenser, or capacitance in parallel with a resistance arm in a Schering bridge.

The use of series resistance in a resonant circuit is illustrated in Figure 1. The unknown capacitance C_x and its dissipation factor D_x are given by

$$\begin{aligned} C_x &= \Delta C \\ D_x &= \frac{C'^2}{C_x} \omega \Delta R \end{aligned} \quad (1)$$

where $\Delta C = C' - C$ and $\Delta R = R' - R$ and the initial values, when the unknown is not in circuit, are denoted by primes. Values of the coupling and tuning inductance L and its effective resistance R_L do not enter these equations.

FIGURE 1. Circuit for measuring a condenser by the parallel substitution method, in which the dissipation factor is determined by the change in setting of the series resistance R .

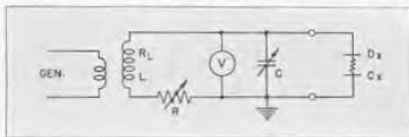

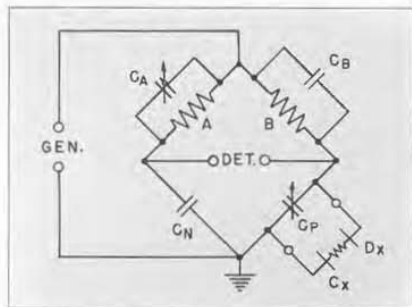

FIGURE 2. Circuit for parallel substitution method with a Schering bridge. The dissipation factor of the unknown is determined from the change in setting of C_A .

In the Schering bridge shown in Figure 2 the expressions for C_x and D_x are

$$\begin{aligned} C_x &= \Delta C_P \\ D_x &= \frac{C'_P}{C_x} \Delta Q_A \end{aligned} \quad (2)$$

where $\Delta C_P = C'_P - C_P$ and $\Delta Q_A = Q_A - Q'_A = (C_A - C'_A)\omega A$. Here the resistance arm A enters, but only as a factor. None of the elements in the B and N arms appear.

ERRORS AT RADIO FREQUENCIES

In addition to the dielectric loss in the stator supports, an air condenser has two other residual impedances, series inductance and series resistance, in the leads to the stator and rotor and in the condenser plates themselves.¹ The effects of these two residuals in parallel substitution measurements are negligible at low frequencies, but at high frequencies they become of great importance. On the other hand, they produce no error in series substitution methods because they also are practically unaffected by the position of the rotor.

¹ R. F. Field and D. B. Sinclair, "A Method for Determining the Residual Inductance and Resistance of a Variable Air Condenser at Radio Frequencies," Proc. I.R.E., Vol. 24, No. 2, February, 1936.

These residuals can also occur in all parts of any measuring network and constitute the real difference between high- and low-frequency measurements.

A good representation of an air condenser is shown in Figure 3. The series inductance L_C increases the total capacitance according to the equation

$$\hat{C} = \frac{C}{1 - \omega^2 L_C C} \quad (3)$$

where $C = C' + C_0$. For a TYPE 722-D Precision Condenser L_C is 0.06 μ h. For a capacitance setting of 1000 μ mf the error introduced by this inductance becomes 0.1% at about 600 kc. At higher frequencies the error increases rapidly because frequency appears squared in Equation (3). The errors occurring for various capacitances at different frequencies are shown in Figure 4. This error has increased to 10% at 6 Mc, while at 20 Mc this 10% error occurs for only 100 μ mf. In the TYPE 722-N Precision Condenser L_C has been reduced to 0.006 μ h. The curves of Figure 4 may be applied to this condenser by multiplying by 3 the frequency assigned to each curve.

The series resistance R_C increases the dissipation factor D of the air condenser according to the relation

$$D = \frac{D_0 C_0}{C} + R_C \omega C \quad (4)$$

where $D_0 C_0$ is the figure of merit of

FIGURE 3. Equivalent circuit of an air condenser. $D_0 C_0$ represents the fixed capacitance and dissipation factor of the solid dielectric. This is in parallel with a lossless variable capacitance, C' . L_C and R_C are series inductance and series resistance of the leads, plates, and supports.

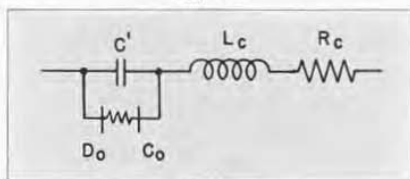

the air condenser. For a TYPE 722-D Precision Condenser $D_0 C_0 = .04 \mu\mu f$ and $R_C = .02 \Omega$ at 1 Mc. Even at this frequency skin-effect is complete, so that the series resistance varies as the square root of the frequency. Values of the two components of dissipation factor are plotted in Figure 5. Even at a frequency of 1 Mc the component of dissipation factor contributed by series resistance equals that from dielectric loss at a capacitance of 600 $\mu\mu f$. In the TYPE 722-N Precision Condenser $R_C = .005 \Omega$ at 1 Mc. The curves of Figure 5 will apply to this condenser by multiplying by 2 the frequency assigned to each curve.

When these effects of series inductance and series resistance are taken into account by substituting Equations (3) and (4) in Equations (1) and (2), the expressions for capacitance and dissipation factor become

$$C_x = \frac{\Delta C_P}{1 - \omega^2 L_C \Sigma C_P} \quad (5)$$

$$D_x = \frac{C'_P}{C_x} (1 + \omega^2 L_C C'_P) \Delta Q_A + R_C \omega \Sigma C_P$$

where $\Sigma C_P = C'_P + C_P$ and where terms containing higher powers of ω than the square are omitted. Since ΣC_P is always greater than ΔC_P , the errors

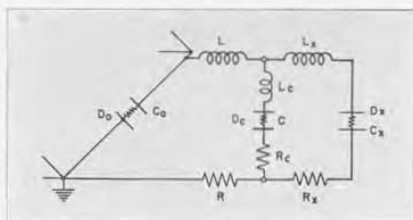

FIGURE 6. Circuit showing the residual impedances affecting substitution measurements with the radio-frequency bridge.

introduced by series inductance and resistance are always greater than those shown in Figures 4 and 5 on the assumption that abscissae of these plots are the unknown capacitance C_x .

TYPE 516-C RADIO-FREQUENCY BRIDGE

Substitution measurements can be made on the TYPE 516-C Radio-Frequency Bridge either by using the internal calibrated condenser or an external TYPE 722-D Precision Condenser. In either case there will be additional residual impedances, beside those shown in Figure 3, in that arm of the bridge containing the capacitance standard.

FIGURE 4. Percentage error in capacitance of a TYPE 722-D Precision Condenser as a function of setting for frequencies up to 20 Mc.

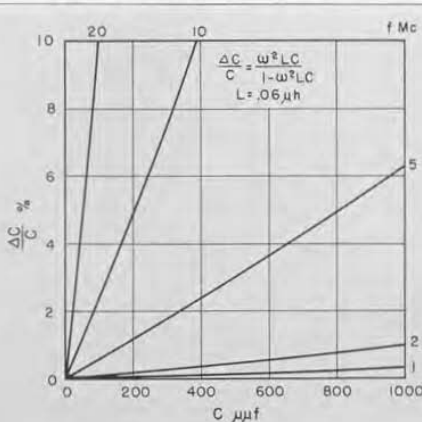
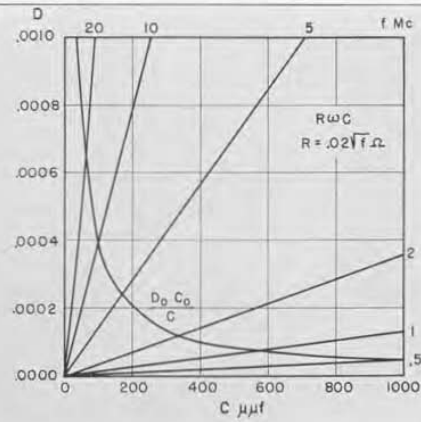

FIGURE 5. Plot of the two components of dissipation factor as functions of frequency and scale setting for TYPE 722-D Precision Condenser.



As shown in Figure 6, these include inductance L and resistance R in series with the standard condenser and capacitance C_0 shunted across the whole arm. In addition, inductance L_x and resistance R_x are shown in series with the unknown condenser C_x , since frequently it is impossible to connect the unknown impedance directly to the terminals of the standard condenser. The expression for the equivalent capacitance of the unknown condenser is unchanged from that given in Equation (5); while the expression for dissipation factor is expanded to take in the effect of the added residuals.

$$\hat{C}_x = \frac{\Delta C}{1 - \omega^2 L_C \Sigma C} \tag{6}$$

$$\hat{D}_x = \frac{C'}{C_x} \left[1 - \omega^2 C'(L - L_C) + \frac{C_0}{C'} \right] \Delta Q_A + R_C \omega \Sigma C$$

Subscripts P are omitted so that Equation (6) may be applicable to either bridge arm. If the connection residuals L_x and R_x can be determined the values of C_x and R_x are given by:

$$C_x = \frac{\hat{C}_x}{1 + \omega^2 L_x \hat{C}_x} \tag{7}$$

$$D_x = \hat{D}_x - R_x \omega \hat{C}_x$$

In the TYPE 516-C Radio-Frequency Bridge the two shunt capacitances C_{NO} and C_{PO} are adjusted to equality with an average value of 40 μmf . Similarly, the two series inductances L_N and L_P are adjusted to equality with an average value of 1.9 μh . The correct value to be used for L in Equation (6) depends on which standard condenser, external or internal, is used. For an external TYPE 722-D Precision Condenser connected into the P -arm, the inductance of the leads from bridge to condenser must be added. This inductance can be calculated with sufficient exactness by allowing 0.03 μh per inch of the

FIGURE 7. Examples of straight-line plots for obtaining values of the residuals L_C and R_C .

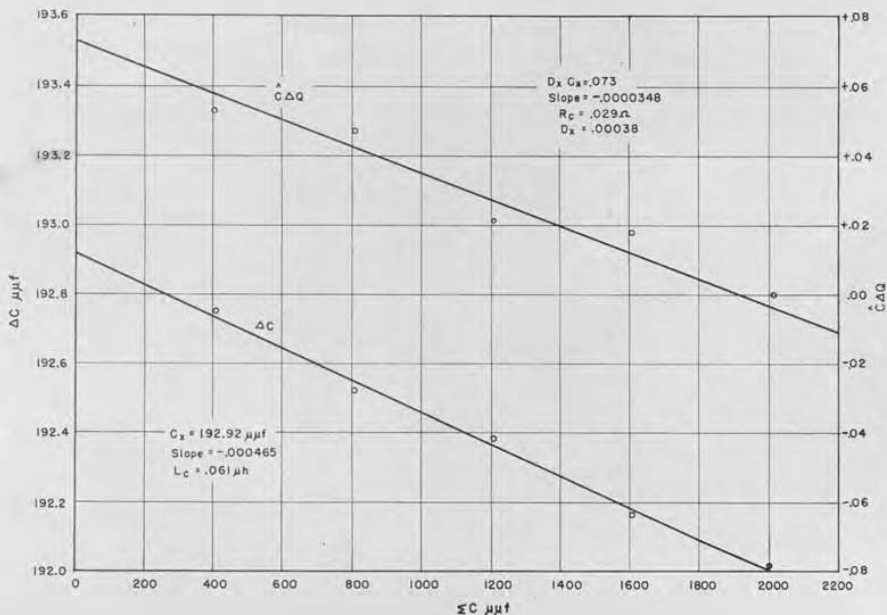

pair of leads.² A reasonable length is 3 inches, giving an inductance of 0.1 μh and a value for L of 2.0 μh . For the internal condenser the leads to the PARALLEL CONDENSER terminals connect to the internal condenser leads at some distance from that condenser, with the result that the series inductance L_C is 0.28 μh . This leaves 1.6 μh for L in the N -arm. The series resistances for the two condensers at a frequency of 1 Mc are, for the external TYPE 722-D Precision Condenser 0.02 Ω , for the internal TYPE 539 Condenser 0.04 Ω . The leads up to the PARALLEL CONDENSER terminals have a combined length of 3 inches and hence have an inductance of about 0.1 μh . The values of these residual impedances are collected in Table I. Values of L_x and R_x for the P -arm depend upon the length of the leads used. Their inductance may be calculated from their length, diameter, and spacing.² Both residuals can be measured by using a condenser which can be connected both to the ends of the leads and directly to the terminal of the external precision condenser.

Exact values of the condenser residuals L_C and R_C can be found by measuring a given fixed condenser using different values of initial capacitance C' . The capacitance of this fixed condenser should lie between 200 and 500 μmf in order to obtain a sufficient dispersion of points while still allowing

TABLE I

	N -arm	P -arm
C_0	40 μmf	40 μmf
L	1.6 μh	2.0 μh
L_C	.28 μh	.06 μh
R_L	.04 Ω	.02 Ω
L_x	.10 μh	

²This value holds for a pair of No. 16 wires $\frac{3}{4}$ inch on centers. The inductance of two parallel wires a cm long, d cm in diameter, and D cm apart between centers is $L = 0.004 a (2.303 \log_{10} \frac{2D}{d} - \frac{D}{a} + .25) \mu\text{h}$.

sufficient fractional accuracy for each individual measurement. While it is possible to calculate the values of the residuals from any two sets of observations, it is preferable to obtain at least six sets and plot them in such a manner as to yield straight lines. Transposing Equation (6) for this purpose

$$C' \left[1 - \omega^2 C' (L - L_C) + \frac{C_0}{C'} \right] \Delta Q_A = \begin{aligned} & \Delta C = -\omega^2 L_C C_z \Sigma C + C_x \\ & -R_C \omega C_z \Sigma C + D_z C_x \end{aligned} \quad (8)$$

The quantities to be used as co-ordinates for plotting are ΣC for abscissa in both plots and ΔC and $\hat{C} \Delta Q_A$ as ordinates. The residuals L_C and R_C are obtained from the slopes of the resulting straight lines, while the intercepts yield the capacitance C_x and dissipation factor D_z of the fixed condenser. Plots of data thus obtained using a TYPE 505-B Mica Condenser and an external TYPE 722-D Precision Condenser are shown in Figure 7. The values obtained are typical and the differences from the nominal values given in Table I are what must be expected. In order to obtain even as good consistency of the observed data as is shown in Figure 7, the precision condenser must be provided with a worm correction and the dissipation factor dial of the bridge must be balanced and read to 0.00001. For this reason data obtained with the internal standard condenser are much less consistent, for it is hardly possible to read total capacitance on the internal condenser to 1 μmf .

It will be found best for all ordinary measurements to use Equation (6) and the data of Table I in reducing observations. Only in quite special cases is it worth while to take sufficient data to make the straight line plots. On the

other hand, it is well to obtain data of this nature at intervals to check the adjustments and constants of the bridge

and to appreciate the care with which the bridge balances must be made in order to obtain accurate results.

— R. F. FIELD

MISCELLANY

● **GENERAL RADIO** engineers have delivered several technical papers in the last few weeks. The measurement and analysis of sound and vibration were discussed by H. H. Scott before the Boston Section, A.I.E.E. on April 9, and at a meeting of the Physics Research Academy of Boston College on April 10. On April 12, Mr. Scott also addressed the Boston Power Transmission Club and the Boston Plant Engineers' Club on the subject of "Electronic Equipment in the Mechanical Field."

R. F. Field spoke, on March 20, before a group of engineers at the General Electric Company, Pittsfield, Mass., on "Impedance Measurements at High

Frequencies." Mr. Field was also the speaker at the April 11 meeting of the Worcester Section, A.I.E.E. His subject was "Dielectric Measurements Over a Very Wide Range of Frequency."

A. E. Thiessen was the speaker at the April 19 meeting of the Baltimore Section, I.R.E. His subject was "Recent Developments in Measuring Instruments."

● **RECENT VISITORS** to the General Radio plant and laboratories include B. J. Thompson of RCA Radiotron, H. P. Corwith and L. B. Root of Western Union, P. E. Nokes of United Shoe Machinery Corporation, and S. Silverman of DuPont Rayon Company.

***T**HE General Radio EXPERIMENTER is mailed without charge each month to engineers, scientists, technicians, and others interested in communication-frequency measurement and control problems. When sending requests for subscriptions and address-change notices, please supply the following information: name, company name, company address, type of business company is engaged in, and title or position of individual.*

GENERAL RADIO COMPANY

30 STATE STREET - CAMBRIDGE A, MASSACHUSETTS

BRANCH ENGINEERING OFFICES

90 WEST STREET, NEW YORK CITY

1000 NORTH SEWARD STREET, LOS ANGELES, CALIFORNIA

